

Tact Switches for SMT

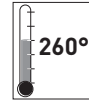

Specifications:

Contact rating:	12 V DC, 50 mA
Contact resistance:	< 100 mΩ
Insulation resistance:	> 100 MΩ at 500 V DC
Dielectric strength:	250 V, 50 Hz for the duration of 1 minute
Operating temperature:	- 25° to + 70° C
Electrical life:	2,6 N: minimum 100 000 cycles 1,6 N: minimum 200 000 cycles
Operating force:	see ordering code
Contacts:	phosphor bronze, silver-plated
Terminals:	brass, silver-plated
Material:	cover: stainless steel base and stem: high-temp. nylon meets UL 94 V-0; caps ABS
Mounting:	on pc-board – SMD
Soldering conditions:	hand-soldering – max.: 30 W, 2 sec, 320° C
Packing:	on tapes – see ordering code
Travel:	0,35 mm + 0,2/- 0,1 mm

Models:

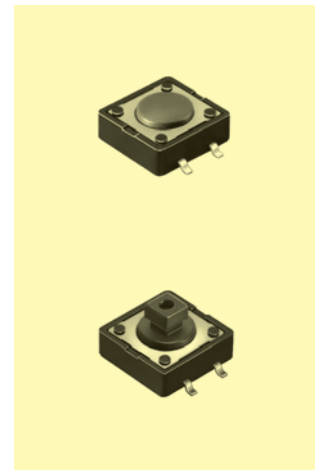
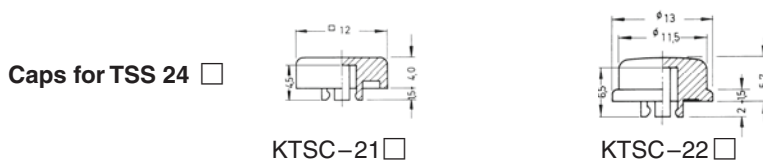
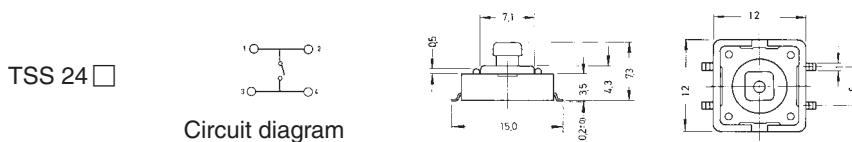
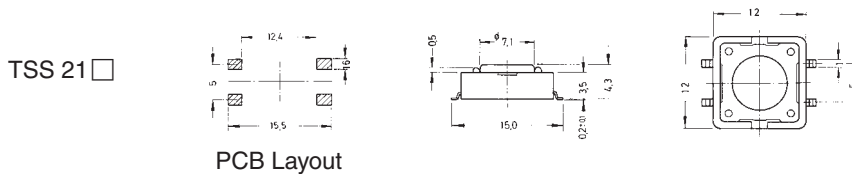

Ordering code:

Switches	TSS 2 <input type="checkbox"/> <input type="checkbox"/>	Colour of stem for operating force:	Caps	KTSC-2 <input type="checkbox"/> <input type="checkbox"/>	Cap colour:
Dimension / Packing:			Cap type:		
<input type="checkbox"/> 4,3 mm / 700 pcs/reel		<input type="checkbox"/> 1,6 N, brown	<input type="checkbox"/> square		<input type="checkbox"/> yellow
<input type="checkbox"/> 7,3 mm / 500 pcs/reel		<input type="checkbox"/> 2,6 N, red	<input type="checkbox"/> round		<input type="checkbox"/> blue
					<input type="checkbox"/> red
					<input type="checkbox"/> ivory
					<input type="checkbox"/> black
					<input type="checkbox"/> green



Tact Switches

Specifications:

Contact rating:	12 V DC, 50 mA
Contact resistance:	< 100 mΩ
Insulation resistance:	> 100 MΩ at 500 V DC
Dielectric strength:	250 V, 50 Hz for the duration of 1 minute
Operating temperature:	- 25° to + 70° C
Electrical life:	2,6 N: minimum 100 000 cycles 1,6 N: minimum 200 000 cycles
Operating force:	see ordering code
Contacts:	phosphor bronze, silver-plated
Terminals:	PC terminals, brass, silver-plated
Material:	cover: stainless steel base and stem: nylon meets UL 94 V-0
Mounting:	on pc-board
Soldering conditions:	hand-soldering – max.: 30 W, 2 sec, 320° C auto-soldering – max.: 5 sec, 260° C subject to PCB 1,6 mm thickness
Travel:	0,35 mm + 0,2/- 0,1 mm

Models:

TS 21 □

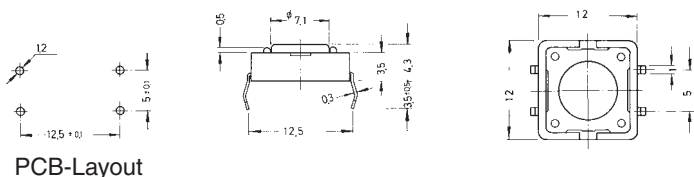

TS 24 □

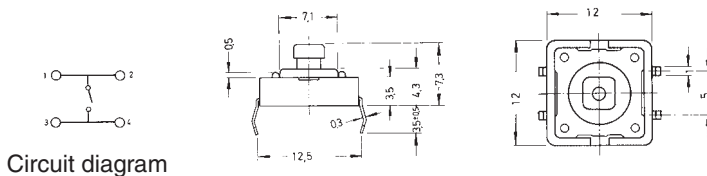

Caps for TS 24 □

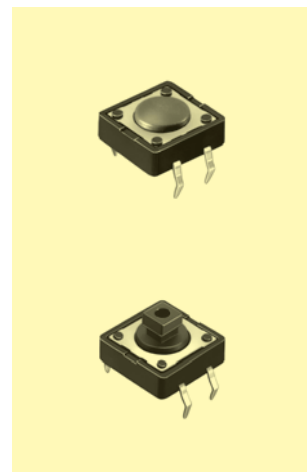
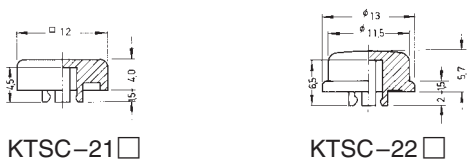

Ordering code:

Switches TS 2 □ □

Dimension:
 1 4,3 mm
 4 7,3 mm

Colour of stem
for operating force:
 N 1,6 N, brown
 R 2,6 N, red

Caps KTSC-2 □ □

Cap type:
 1 square
 2 round

Cap colour:
 Y yellow
 B blue
 R red
 I ivory
 K black
 G green

Tact Switches for SMT



Specifications:

Contact rating:	50 V DC, 50 mA
Contact resistance:	<100 mΩ
Insulation resistance:	>1000 MΩ
Dielectric strength:	250V, 50Hz for the duration of 1 minute
Operating temperature:	-40°C to +85°C
Operating force:	N: 1.6N ± 0.5N
	R: 2.6N ± 0.5N
Mechanical life:	minimum 1 000 000 operations
Material:	Contacts: stainless steel, silver-plated
	Terminals: brass, silver plated
	Cover: stainless steel
	Base: LCP, UL 94 V-0, black, washable
	Stem: PA, UL 94 V-0
	Mounting: on pc-board – SMD

Models:

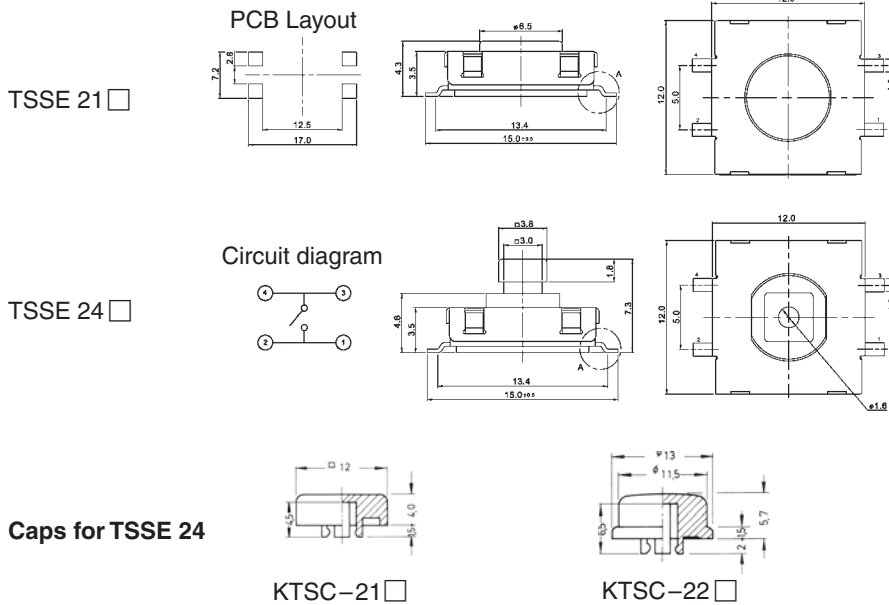

washable

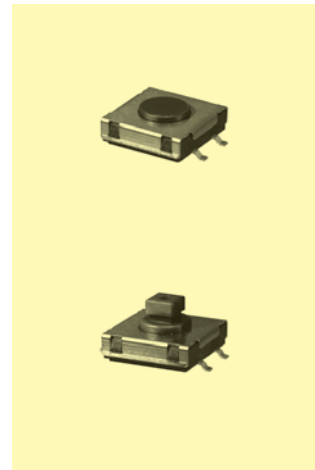

Ordering code:

Switches **TSSE 2**

Dimension / Packing:
 4,3 mm / 700 pcs/reel
 7,3 mm / 500 pcs/reel

Colour of stem for operating force:
 1,6 N, brown
 2,6 N, red

Caps **KTSC-2**

Cap type:
 square
 round

Cap colour:
 yellow
 blue
 red
 ivory
 black
 green



Tact Switches

Specifications:

Contact rating:	50 V DC, 50 mA
Contact resistance:	<100 mΩ
Insulation resistance:	>1000 MΩ
Dielectric strength:	250V, 50Hz for the duration of 1 minute
Operating temperature:	-40°C to +85°C
Operating force:	N: 1.6N ± 0.5N R: 2.6N ± 0.5N
Mechanical life:	minimum 1 000 000 operations
Material:	Contacts: stainless steel, silver-plated Terminals: brass, silver plated Cover: stainless steel Base: LCP, UL 94 V-0, black, washable Stem: PA, UL 94 V-0
Mounting:	on pc-board
Soldering conditions:	wave soldering, max. 5 s max. 260 °C, pre-heat max. 60 s max. 100 °C
Travel:	0.35 mm ± 0.15 mm

3

Models:

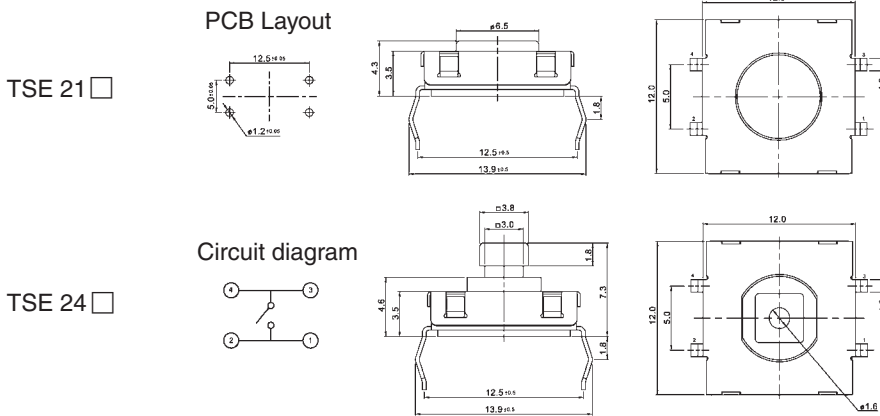

washable



Caps for TSE 24



Ordering code:

Switches TSE 2

Dimension:
 4,3 mm
 7,3 mm

Colour of stem for operating force:
 1,6 N, brown
 2,6 N, red

Caps KTSC-2

Cap type:
 square
 round

Cap colour:
 yellow
 blue
 red
 ivory
 black
 green

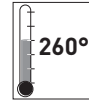

Specifications:

Contact rating:	12 V DC, 50 mA
Contact resistance:	< 100 mΩ
Insulation resistance:	> 100 MΩ at 500 V DC
Dielectric strength:	250 V, 50 Hz for the duration of 1 minute
Operating temperature:	- 40° to + 85° C
Electrical life:	1,0 N/1,6 N: minimum 200 000 cycles 2,6 N: minimum 100 000 cycles 3,2 N/5,2 N: minimum 50 000 cycles
Operating force:	see ordering code
Contacts:	phosphor bronze, silver-plated
Terminals:	brass, silver-plated
Material:	cover: stainless steel base and stem: nylon meets UL 94 V-0; caps ABS
Mounting:	on pc-board – SMD
Soldering conditions:	hand-soldering – max.: 30 W, 2 sec, 320° C
Travel:	0,25 mm + 0,2/- 0,1 mm

Models:

TSS 6

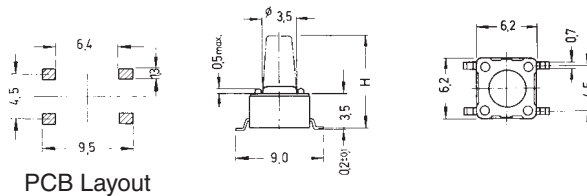

TSS 644

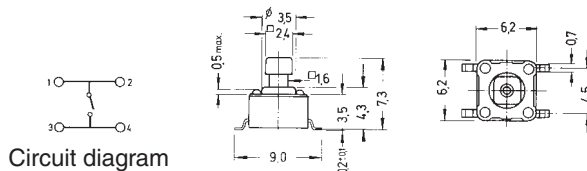

Caps for TSS 644

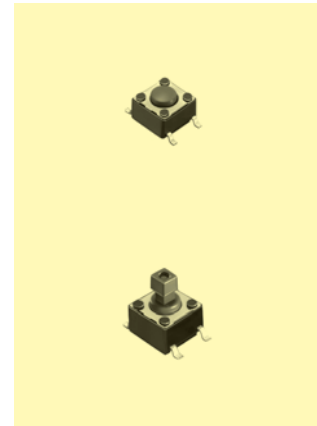

Ordering code:

Switches

TSS 6

Dimension H / Packing:

- 1 4,3 mm / 1000 pcs / reel
- 2 5,0 mm / 900 pcs / reel
- 3 7,0 mm / 700 pcs / reel
- 44 7,3 mm / 500 pcs / reel*
- 5 9,5 mm / 380 pcs / reel
- 6 13,0 mm / 77 pcs / tube
200 pcs / reel

Colour of stem
for operating force:

- K 1,0 N, black
- N 1,6 N, brown
- R 2,6 N, red
- S 3,2 N, salmon
- Y 5,2 N, yellow

* only with square stem

Caps KTSC-6

Cap type:

- 1 square
- 2 round

Cap colour:

- Y yellow
- B blue
- R red
- I ivory
- K black
- G green



Specifications:

Contact rating:	12 V DC, 50 mA
Contact resistance:	< 100 mΩ
Insulation resistance:	> 100 MΩ at 500 V DC
Dielectric strength:	250 V, 50 Hz for the duration of 1 minute
Operating temperature:	- 40° to + 85° C
Electrical life:	1,0 N/1,6 N: minimum 200 000 cycles 2,6 N: minimum 100 000 cycles 3,2 N/5,2 N: minimum 50 000 cycles
Operating force:	see ordering code
Contacts:	phosphor bronze, silver-plated
Terminals:	PC terminals, brass, silver-plated
Material:	cover: stainless steel base and stem: nylon meets UL 94 V-0; caps ABS
Mounting:	on pc-board
Soldering conditions:	hand-soldering – max.: 30 W, 2 sec, 320° C auto-soldering – max.: 5 sec, 260° C subject to PCB 1,6 mm thickness
Travel:	0,25 mm + 0,2/- 0,1 mm

Models:

TS 6

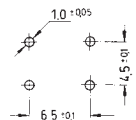

PCB Layout

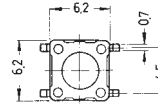
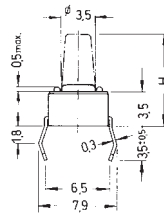

TS 644



Circuit diagram

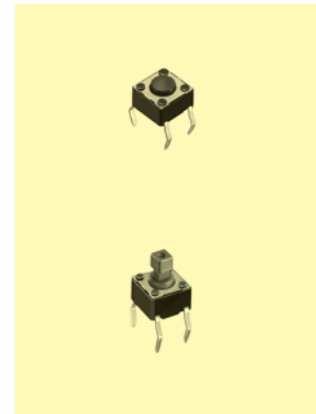
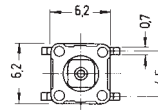
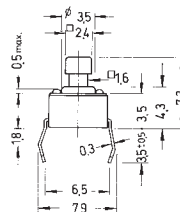

Caps for TS 644

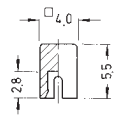

KTSC-61

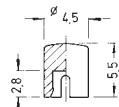

KTSC-62

Ordering code:

Switches TS 6

Dimension H

- 1 4,3 mm
- 2 5,0 mm
- 3 7,0 mm
- 4 7,3 mm*
- 5 9,5 mm
- 6 13,0 mm

Colour of stem for operating force:

- K 1,0 N, black
- N 1,6 N, brown
- R 2,6 N, red
- S 3,2 N, salmon
- Y 5,2 N, yellow

Caps KTSC-6

Cap type:

- 1 square
- 2 round

Cap colour:

- Y yellow
- B blue
- R red
- I ivory
- K black
- G green

* only with square stem

Tact Switches

Specifications:

Contact rating:	12 V DC, 50 mA
Contact resistance:	< 100 mΩ
Insulation resistance:	> 100 MΩ at 500 V DC
Dielectric strength:	250 V, 50 Hz for the duration of 1 minute
Operating temperature:	- 40° to + 85° C
Electrical life:	1,0 N/1,6 N: minimum 200 000 cycles 2,6 N: minimum 100 000 cycles 3,2 N/5,2 N: minimum 50 000 cycles
Operating force:	see ordering code
Contacts:	phosphor bronze, silver-plated
Terminals:	PC terminals, brass, silver-plated
Material:	cover: steel, tin-plated base and stem: nylon meets UL 94 V-0; caps ABS
Mounting:	on pc-board
Soldering conditions:	hand-soldering – max.: 30 W, 2 sec, 320° C auto-soldering – max.: 5 sec, 260° C subject to PCB 1,6 mm thickness
Travel:	0,25 mm + 0,2/- 0,1 mm

Models:

TS 6□-RA

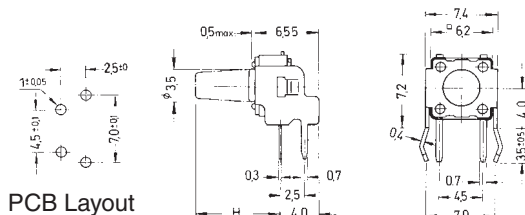

TS 644□-RA

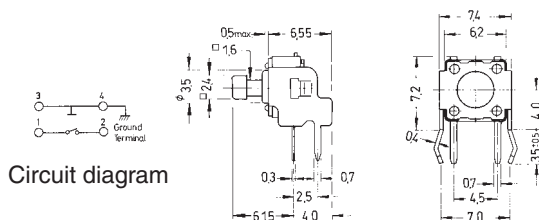

Caps for TS 644□-RA



Ordering code:

Switches TS 6□□-RA

Dimension H

- 1 3,15 mm
- 2 3,85 mm
- 3 5,85 mm
- 4 6,15 mm*
- 5 8,35 mm
- 6 11,85 mm

Colour of stem for operating force:

- K 1,0 N, black
- N 1,6 N, brown
- R 2,6 N, red
- S 3,2 N salmon
- Y 5,2 N, yellow

Caps KTSC-6□□

Cap type:

- 1 square
- 2 round

Cap colour:

- Y yellow
- B blue
- R red
- I ivory
- K black
- G green

* only with square stem

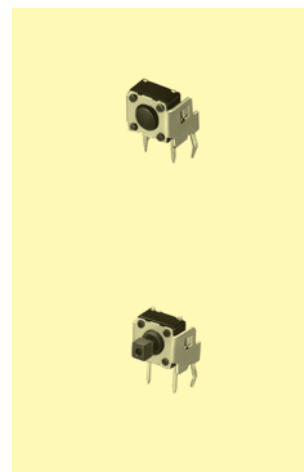

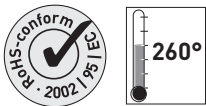

Specifications:

Contact rating:	24 V DC, 100 mA max.
Contact resistance:	< 100 mΩ
Insulation resistance:	> 100 MΩ at 500 V DC
Dielectric strength:	250 V AC, 50 Hz for the duration of 1 minute
Operating temperature:	- 55° to + 125° C
Electrical life:	minimum 100 000 cycles
Operating force:	3,0 ± 1,0 N
Contacts/terminals:	gold-plated/silver-plated
Material:	cover: stainless steel, base: high-temp. nylon meets UL 94 V-0, stem: silicone rubber
Mounting:	on pc-board – SMD
Soldering conditions:	max.: 5 sec, 260° C
Travel:	max. 1,27 mm

Models:

Switching functions:

washable

TMSE 10

off – mom

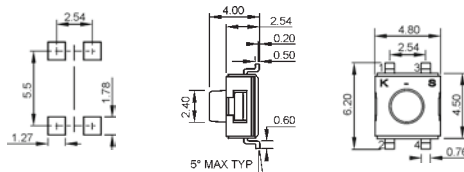

TMSE 10 J

off – mom

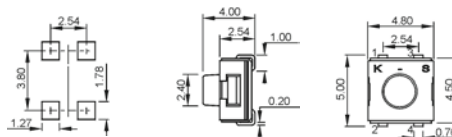

TMSE 10 J-RA

off – mom

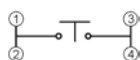
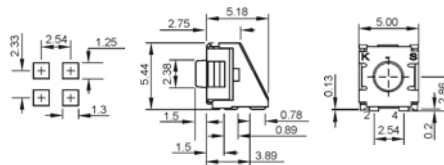

Packing:

TMSE 10:	500 pcs/reel
TMSE 10 J:	500 pcs/reel
TMSE 10 J-RA:	200 pcs/reel

Tact Switches for SMT



Specifications:

Contact rating:	12 V DC, 50 mA / 1 V DC, 0,5 mA
Contact resistance:	< 100 mΩ
Insulation resistance:	> 2 GΩ at 100 V DC
Dielectric strength:	250 V, 50 Hz for the duration of 1 minute
Operating temperature:	- 25° to + 70° C
Electrical life:	minimum 50 000 cycles
Operating Force:	2,15 N ± 0,6 N
Contacts:	metal contact, stainless steel, silver-plated
Terminals:	phosphor bronze, silver-plated
Material:	case: PPS meets UL 94 V-0, brown button: PA meets UL 94 V-0, black frame: phosphor bronze, tin-plated
Mounting:	on pc-board – SMD
Travel:	0,3 mm + 0,2/-0,1 mm

Model:

TSS 4-RA

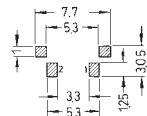

PCB Layout



Circuit diagram

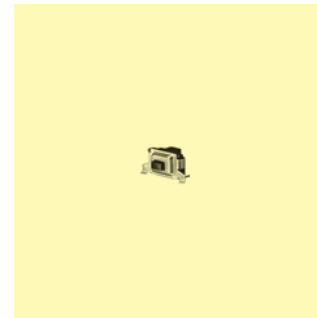
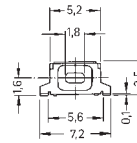
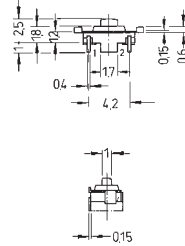

Packing:

2000 pcs/reel

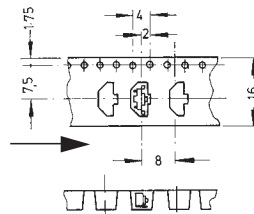

Soldering conditions:

reflow-soldering: 40 sec, 200° C
peak temperature 230° C

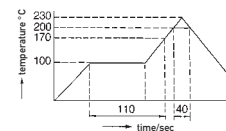

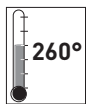

Tact Switches

Specifications:

Contact rating:	12 V DC, 50 mA
Contact resistance:	< 100 mΩ
Insulation resistance:	> 100 MΩ at 500 V DC
Dielectric strength:	250 V, 50 Hz for the duration of 1 minute
Operating temperature:	- 25° to + 70° C
Electrical life:	1,6 N: minimum 1 000 000 cycles 3,2 N: minimum 300 000 cycles
Operating force:	see ordering code
Contacts:	stainless steel, silver-plated
Terminals:	brass, silver-plated
Material:	cover: stainless steel base and stem: high-temp. nylon meets UL 94 V-0 or PPA
Mounting:	TS 3: on PC-board TSS 3: on PC-board – SMD
Soldering conditions:	TS 3: hand-soldering – max.: 30 W, 2 sec, 320° C auto-soldering – max.: 5 sec, 260° C subject to PCB 1,6 mm thickness
TSS 3:	reflow-soldering, see page 5
Travel:	0,25 mm + 0,2/- 0,1 mm

Models:

TS 3

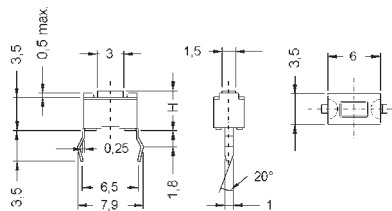
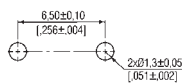

TSS 3

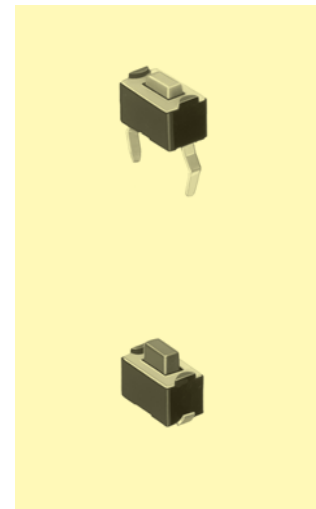
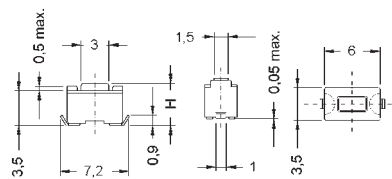
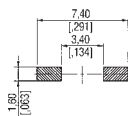

Ordering Code: TS 3 / TSS 3

Dimension H

- 1 4,3 mm
- 2 5,0 mm

Colour of stem for operating force:

- N brown, 1,6 N
- S salmon, 3,2 N

Packing:	TS 3	in tubes, 135 pieces / tube
	TSS 31	on tape, 1800 pieces / reel
	TSS 32	on tape, 1600 pieces / reel

Tact Switches for SMT

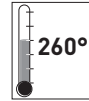

Specification:

Contact rating:	12 V DC, 50 mA
Contact resistance:	<500 mΩ
Insulation resistance:	>10 MΩ
Dielectric strength:	100V, 50Hz for the duration of 1 minute
Operating temperature:	-40°C to +85°C
Operating force:	N: 1.8N ± 0.5N S: 3.5N ± 0.9N
Mechanical life:	minimum 1 000 000 operations
Material:	Contacts: stainless steel, silver-plated Terminals: phosphor-bronze, silver plated Case: PA46, black Actuator: TSS 309: PA46, blue, TSSE 310: silicone rubber, black
Water proofing:	TSSE 310: IP 67
Mounting:	on pc-board
Packaging:	2500 pcs/reel

Models:

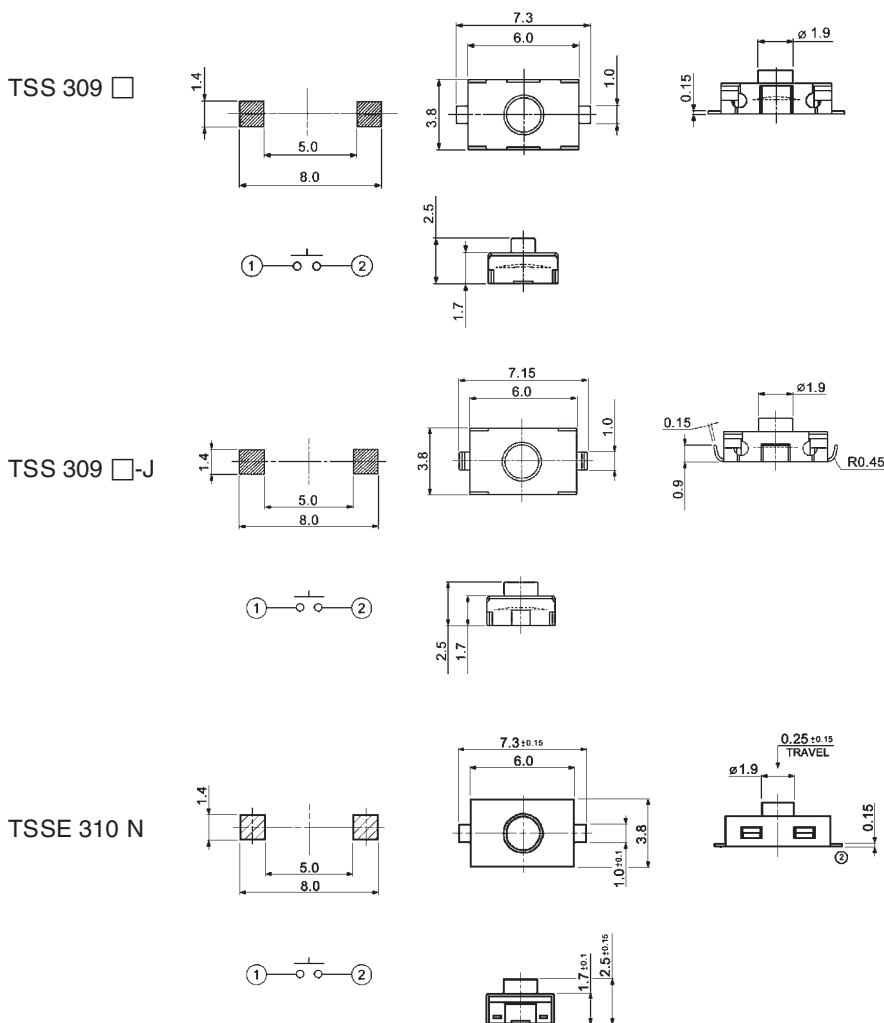

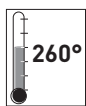

Tact Switches for SMT

Specification:

Contact rating:	12 V DC, 50 mA
Contact resistance:	< 500 mΩ
Insulation resistance:	> 100 MΩ
Dielectric strength:	250 V, 50–60 Hz for the duration of 1 minute
Operating temperature:	– 10° to + 60° C
Operating force:	2,5 N ± 0,7 N
Mechanical life:	100 000 cycles
Contacts:	silver-plated
Mounting:	on pc-board – SMD
Travel:	0,25 mm ± 0,1 mm
Packing:	4000 pcs/reel

3

Model:

TSS 507

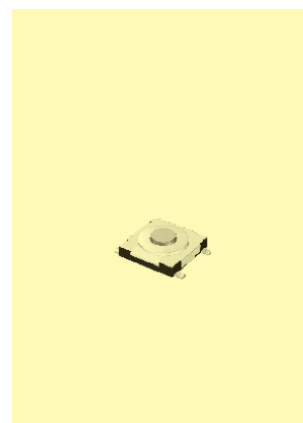
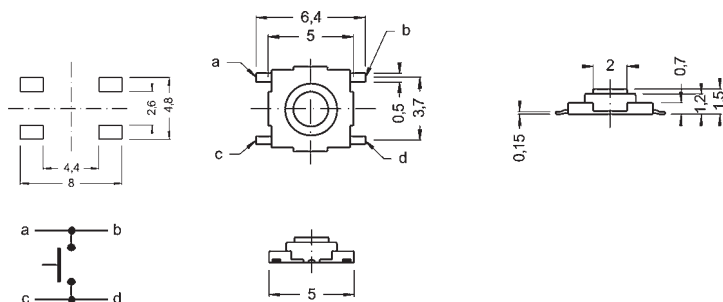

Tact Switches

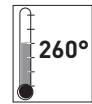

Specification:

Contact rating:	12 V DC, 50 mA
Contact resistance:	< 500 mΩ
Insulation resistance:	> 100 MΩ
Dielectric strength:	250 V, 50–60 Hz for the duration of 1 minute
Operating temperature:	– 20° to + 70° C
Mechanical life:	minimum 50 000 cycles
Contacts:	silver-plated
Mounting:	on pc-board, TSS 313 RA = on pc-board – SMD
Packing unit:	TS 637 RA: 500 pieces/bag TSS 313 RA: 2000 pieces/bag

Models:

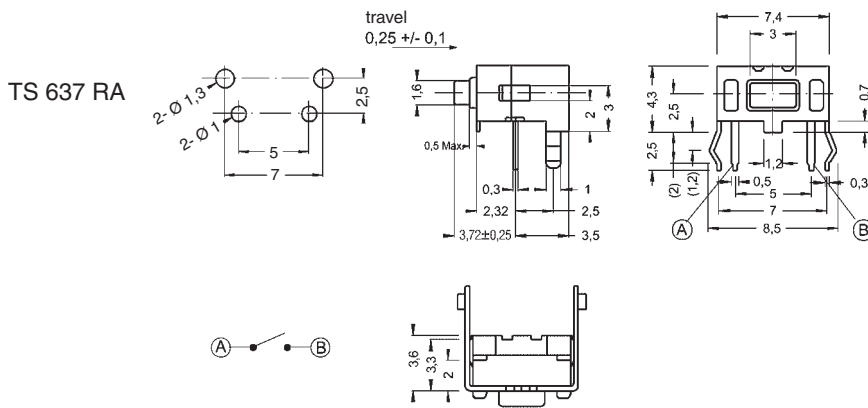

Operating force: 1,6 N ± 0,5 N

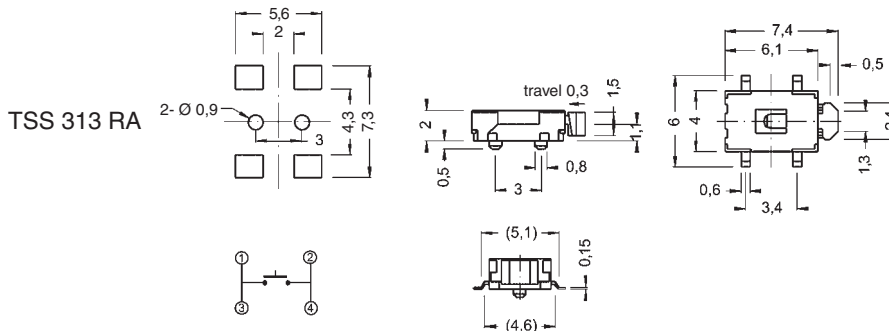

Operating force: 2,5 N ± 0,7 N

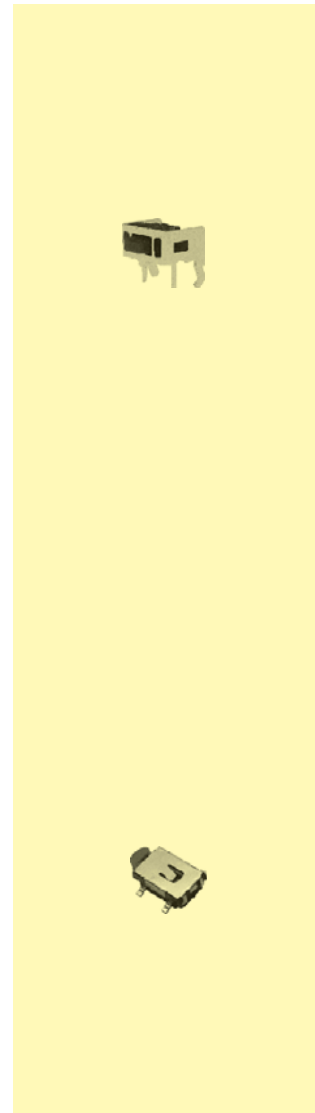

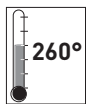

Long Travel Tact switch for SMT

Specifications:

Contact rating:	12 V DC, 50 mA,
Contact resistance:	< 100 mΩ
Insulation resistance:	> 100 MΩ
Dielectric strength:	300 V, 50 Hz for the duration of 1 minute
Operating temperature:	- 40° to + 85° C
Mechanical life:	minimum 100 000 cycles
Operating force:	R: 200 gf ± 50 gf S: 350 gf ± 100 gf
Contacts:	gold-plated
Terminals:	silver-plated
Travel:	1,3 mm + 0,1/- 0,3 mm
Material:	case and actuator: Nylon meets UL 94V-0
Mounting:	on pc-board – SMD
Travel:	1,3 mm + 0,1/- 0,3 mm
Packing:	900 pieces/reel

3

Models:

TSS 650 □-J

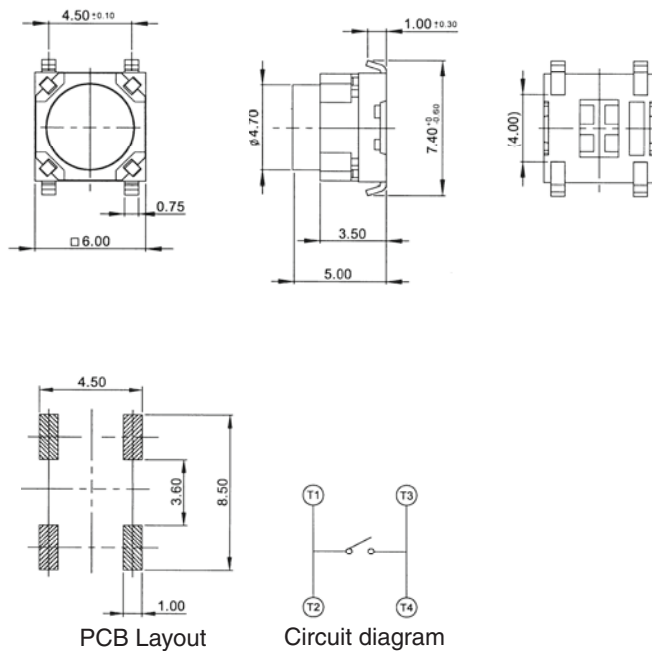

Ordering code: TSS 650 □-J

Operating force: R 2,0 N
 S 3,5 N